

8-BIT LVTTTL-TO-GTLP ADJUSTABLE-EDGE-RATE REGISTERED TRANSCEIVER WITH SPLIT LVTTTL PORT AND FEEDBACK PATH

SCES355C – JUNE 2001 – REVISED SEPTEMBER 2001

- Member of the Texas Instruments Widebus™ Family
- TI-OPC™ Circuitry Limits Ringing on Unevenly Loaded Backplanes
- OEC™ Circuitry Improves Signal Integrity and Reduces Electromagnetic Interference
- Bidirectional Interface Between GTLP Signal Levels and LVTTTL Logic Levels
- Split LVTTTL Port Provides a Feedback Path for Control and Diagnostics Monitoring
- AO Outputs Have Equivalent 26-Ω Series Resistors, So No External Resistors Are Required
- LVTTTL Interfaces Are 5-V Tolerant
- High-Drive GTLP Open-Drain Outputs (100 mA)
- LVTTTL Outputs (–12 mA/12 mA)
- Variable Edge-Rate Control (ERC) Input Selects GTLP Rise and Fall Times for Optimal Data-Transfer Rate and Signal Integrity in Distributed Loads
- I_{off}, Power-Up 3-State, and BIAS V_{CC} Support Live Insertion
- Distributed V_{CC} and GND Pins Minimize High-Speed Switching Noise
- Latch-Up Performance Exceeds 100 mA Per JESD 78, Class II
- ESD Protection Exceeds JESD 22
 - 2000-V Human-Body Model (A114-A)
 - 200-V Machine Model (A115-A)
 - 1000-V Charged-Device Model (C101)

DGG OR DGV PACKAGE
(TOP VIEW)

IMODE1	1	48	IMODE0
A11	2	47	BIAS V _{CC}
AO1	3	46	B1
GND	4	45	GND
A12	5	44	OEAB
AO2	6	43	B2
V _{CC}	7	42	ERC
A13	8	41	OEAB
AO3	9	40	B3
GND	10	39	GND
A14	11	38	CLKAB/LEAB
AO4	12	37	B4
AO5	13	36	B5
A15	14	35	CLKBA/LEBA
GND	15	34	GND
AO6	16	33	B6
A16	17	32	OEBA
V _{CC}	18	31	V _{CC}
AO7	19	30	B7
A17	20	29	LOOPBACK
GND	21	28	GND
AO8	22	27	B8
A18	23	26	V _{REF}
OMODE0	24	25	OMODE1

description

The SN74GTLP22034 is a high-drive, 8-bit, three-wire registered transceiver that provides true LVTTTL-to-GTLP and GTLP-to-LVTTTL signal-level translation. The device allows for transparent, latched, and flip-flop modes of data transfer with separate LVTTTL input and LVTTTL output pins, which provides a feedback path for control and diagnostics monitoring, the same functionality as the SN74FB2033, but with true logic. The device provides a high-speed interface between cards operating at LVTTTL logic levels and a backplane operating at GTLP signal levels. High-speed (about three times faster than standard LVTTTL or TTL) backplane operation is a direct result of GTLP's reduced output swing (<1 V), reduced input threshold levels, improved differential input, OEC™ circuitry, and TI-OPC™ circuitry. Improved GTLP OEC and TI-OPC circuits minimize bus-settling time and have been designed and tested using several backplane models. The high drive allows incident-wave switching in heavily loaded backplanes with equivalent load impedance down to 11 Ω.

The AO outputs, which are designed to sink up to 12 mA, include equivalent 26-Ω resistors to reduce overshoot and undershoot.



Please be aware that an important notice concerning availability, standard warranty, and use in critical applications of Texas Instruments semiconductor products and disclaimers thereto appears at the end of this data sheet.

OEC, TI-OPC, and Widebus are trademarks of Texas Instruments.

PRODUCTION DATA information is current as of publication date. Products conform to specifications per the terms of Texas Instruments standard warranty. Production processing does not necessarily include testing of all parameters.

 **TEXAS
INSTRUMENTS**

POST OFFICE BOX 655303 • DALLAS, TEXAS 75265

Copyright © 2001, Texas Instruments Incorporated

SN74GTLP22034

8-BIT LVTTTL-TO-GTLP ADJUSTABLE-EDGE-RATE REGISTERED TRANSCEIVER WITH SPLIT LVTTTL PORT AND FEEDBACK PATH

SCES355C – JUNE 2001 – REVISED SEPTEMBER 2001

description (continued)

GTLP is the Texas Instruments derivative of the Gunning Transceiver Logic (GTL) JEDEC standard JESD 8-3. The ac specification of the SN74GTLP22034 is given only at the preferred higher noise-margin GTLP, but the user has the flexibility of using this device at either GTL ($V_{TT} = 1.2\text{ V}$ and $V_{REF} = 0.8\text{ V}$) or GTLP ($V_{TT} = 1.5\text{ V}$ and $V_{REF} = 1\text{ V}$) signal levels. For information on using GTLP devices in FB+/BTL applications, refer to TI application reports, *Texas Instruments GTLP Frequently Asked Questions*, literature number SCEA019, and *GTLP in BTL Applications*, literature number SCEA017.

Normally, the B port operates at GTLP signal levels. The A-port and control inputs operate at LVTTTL logic levels, but are 5-V tolerant and can be directly driven by TTL or 5-V CMOS devices. V_{REF} is the B-port differential input reference voltage.

This device is fully specified for live-insertion applications using I_{off} , power-up 3-state, and BIAS V_{CC} . The I_{off} circuitry disables the outputs, preventing damaging current backflow through the device when it is powered down. The power-up 3-state circuitry places the outputs in the high-impedance state during power up and power down, which prevents driver conflict. The BIAS V_{CC} circuitry precharges and preconditions the B-port input/output connections, preventing disturbance of active data on the backplane during card insertion or removal, and permits true live-insertion capability.

This GTLP device features TI-OPC circuitry, which actively limits overshoot caused by improperly terminated backplanes, unevenly distributed cards, or empty slots during low-to-high signal transitions. This improves signal integrity, which allows adequate noise margin to be maintained at higher frequencies.

High-drive GTLP backplane interface devices feature adjustable edge-rate control (ERC). Changing the ERC input voltage between low and high adjusts the B-port output rise and fall times. This allows the designer to optimize system data-transfer rate and signal integrity to the backplane load.

When V_{CC} is between 0 and 1.5 V, the device is in the high-impedance state during power up or power down. However, to ensure the high-impedance state above 1.5 V, \overline{OEAB} should be tied to V_{CC} through a pullup resistor and OEAB and OEBA should be tied to GND through a pulldown resistor; the minimum value of the resistor is determined by the current-sinking/current-sourcing capability of the driver.

**GQL PACKAGE
(TOP VIEW)**

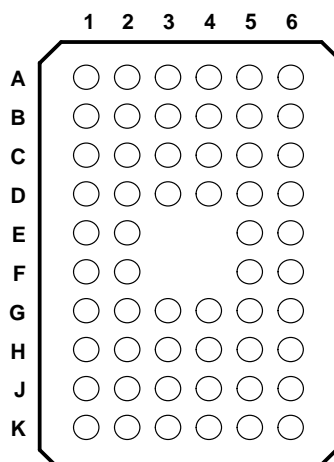

terminal assignments

	1	2	3	4	5	6
A	IMODE1	NC	NC	NC	NC	IMODE0
B	AO1	AI1	GND	GND	BIAS V_{CC}	B1
C	AO2	AI2	V_{CC}	ERC	OEAB	B2
D	AO3	AI3	GND	GND	\overline{OEAB}	B3
E	AO4	AI4			CLKAB/LEAB	B4
F	AO5	AI5			CLKBA/LEBA	B5
G	AO6	AI6	GND	GND	OEBA	B6
H	AO7	AI7	V_{CC}	V_{CC}	LOOPBACK	B7
J	AO8	AI8	GND	GND	V_{REF}	B8
K	OMODE0	NC	NC	NC	NC	OMODE1

NC = No internal connection



SN74GTLP22034

**8-BIT LVTTTL-TO-GTLP ADJUSTABLE-EDGE-RATE REGISTERED TRANSCEIVER
WITH SPLIT LVTTTL PORT AND FEEDBACK PATH**

SCES355C – JUNE 2001 – REVISED SEPTEMBER 2001

ORDERING INFORMATION

T _A	PACKAGE†		ORDERABLE PART NUMBER	TOP-SIDE MARKING
–40°C to 85°C	TSSOP – DGG	Tape and reel	SN74GTLP22034DGGR	GTLP22034
	TVSOP – DGV	Tape and reel	SN74GTLP22034DGVR	GT22034
	VFBGA – GQL	Tape and reel	SN74GTLP22034GQLR	GS034

† Package drawings, standard packing quantities, thermal data, symbolization, and PCB design guidelines are available at www.ti.com/sc/package.

functional description

The SN74GTLP22034 is a high-drive (100 mA), 8-bit, three-wire registered transceiver containing D-type latches and D-type flip-flops for data-path operation in the transparent, latched, or flip-flop modes. Data transmission is true, with AI data going to the B port and B data going to AO. The split LVTTTL AI and AO provides a feedback path for control and diagnostics monitoring.

The logic element for data flow in each direction is configured by two mode (IMODE1 and IMODE0 for B to A, OMODE1 and OMODE0 for A to B) inputs as a buffer, a D-type flip-flop, or a D-type latch. When configured in the buffer mode, the input data appears at the output port. In the flip-flop mode, data is stored on the rising edge of the appropriate clock (CLKAB/LEAB or CLKBA/LEBA) input. In the latch mode, the clock inputs serve as active-high transparent latch enables.

Data flow in the B-to-A direction, regardless of the logic element selected, is further controlled by the LOOPBACK input. When LOOPBACK is low, B-port data is the B-to-A input. When LOOPBACK is high, the output of the selected A-to-B logic element is the B-to-A input.

The AO enable/disable control is provided by OEBA. When OEBA is low or when V_{CC} is less than 1.5 V, AO is in the high-impedance state. When OEBA is high, AO is active (high or low logic levels).

The B port is controlled by OEAB and \overline{OEAB} . If OEAB is low, \overline{OEAB} is high, or V_{CC} is less than 1.5 V, the B port is inactive. If OEAB is high and \overline{OEAB} is low, the B port is active.

The A-to-B and B-to-A logic elements are active, regardless of the state of their associated outputs. The logic elements can enter new data (in flip-flop and latch modes) or retain previously stored data while the associated outputs are in the high-impedance (AO) or inactive (B port) states.



8-BIT LVTTTL-TO-GTLP ADJUSTABLE-EDGE-RATE REGISTERED TRANSCEIVER WITH SPLIT LVTTTL PORT AND FEEDBACK PATH

SCES355C – JUNE 2001 – REVISED SEPTEMBER 2001

Function Tables

FUNCTION/MODE

INPUTS								OUTPUT	MODE
OEBA	OEAB	\overline{OEAB}	OMODE1	OMODE0	IMODE1	IMODE0	LOOPBACK		
L	L	X	X	X	X	X	X	Z	Isolation
L	X	H	X	X	X	X	X	Z	Isolation
X	H	L	L	L	X	X	X	AI to B	Buffer
X	H	L	L	H	X	X	X	AI to B	Flip-flop
X	H	L	H	X	X	X	X	AI to B	Latch
H	L	X	X	X	L	L	L	B to AO	Buffer
H	X	H	X	X	L	L	L	B to AO	Buffer
H	L	X	X	X	L	H	L	B to AO	Flip-flop
H	X	H	X	X	L	H	L	B to AO	Flip-flop
H	L	X	X	X	H	X	L	B to AO	Latch
H	X	H	X	X	H	X	L	B to AO	Latch
H	L	X	X	X	L	L	H	AI to AO	Buffer
H	X	H	X	X	L	L	H	AI to AO	Buffer
H	L	X	X	X	L	H	H	AI to AO	Flip-flop
H	X	H	X	X	L	H	H	AI to AO	Flip-flop
H	L	X	X	X	H	X	H	AI to AO	Latch
H	X	H	X	X	H	X	H	AI to AO	Latch
H	H	L	X	X	X	X	L	AI to B, B to AO	Transparent with feedback path

ENABLE/DISABLE

INPUTS			OUTPUTS	
OEBA	OEAB	\overline{OEAB}	AO	B
L	X	X	Z	
H	X	X	Active	
X	L	L		Z
X	L	H		Z
X	H	L		Active
X	H	H		Z

BUFFER

INPUT	OUTPUT
L	L
H	H

LATCH

INPUTS		OUTPUT
CLK/LE	DATA	
H	L	L
H	H	H
L	X	Q ₀



SN74GTLP22034
8-BIT LVTTTL-TO-GTLP ADJUSTABLE-EDGE-RATE REGISTERED TRANSCEIVER
WITH SPLIT LVTTTL PORT AND FEEDBACK PATH

SCES355C – JUNE 2001 – REVISED SEPTEMBER 2001

Function Tables (Continued)

LOOPBACK

LOOPBACK	Q [†]
L	B port
H	Point P [‡]

[†]Q is the input to the B-to-A logic element.

[‡]P is the output of the A-to-B logic element (see functional block diagram).

SELECT

INPUTS		SELECTED LOGIC ELEMENT
MODE1	MODE0	
L	L	Buffer
L	H	Flip-flop
H	X	Latch

FLIP-FLOP

INPUTS		OUTPUT
CLK/LE	DATA	
L	X	Q ₀
↑	L	L
↑	H	H

B-PORT EDGE-RATE CONTROL (ERC)

INPUT ERC	OUTPUT B-PORT EDGE RATE
LOGIC LEVEL	
H	Slow
L	Fast

SN74GTLP22034

8-BIT LVTTTL-TO-GTLP ADJUSTABLE-EDGE-RATE REGISTERED TRANSCEIVER WITH SPLIT LVTTTL PORT AND FEEDBACK PATH

SCES355C – JUNE 2001 – REVISED SEPTEMBER 2001

functional block diagram

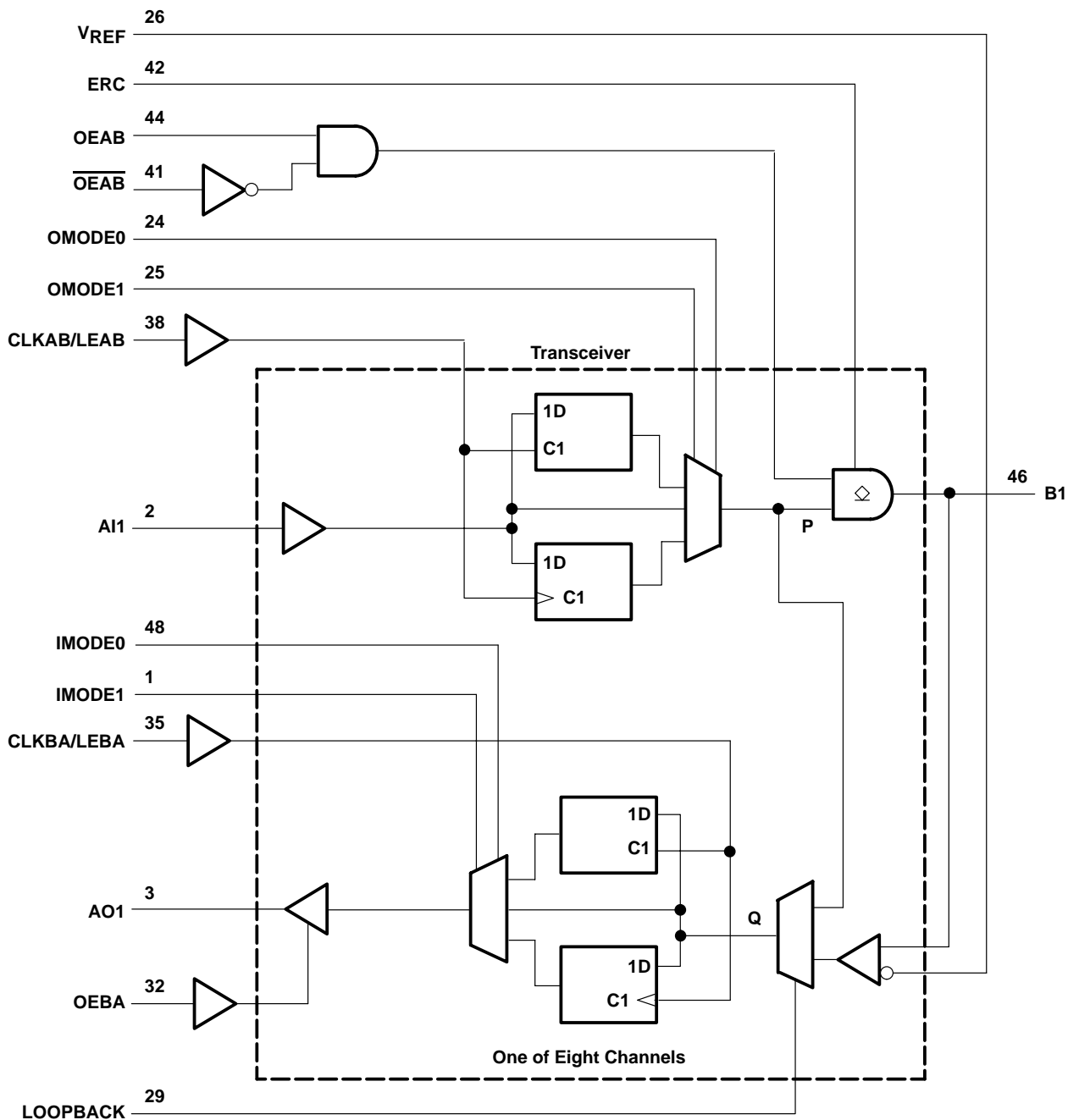

Pin numbers shown are for the DGG and DGV packages.



POST OFFICE BOX 655303 • DALLAS, TEXAS 75265

SN74GTLP22034

**8-BIT LVTTTL-TO-GTLP ADJUSTABLE-EDGE-RATE REGISTERED TRANSCEIVER
WITH SPLIT LVTTTL PORT AND FEEDBACK PATH**

SCES355C – JUNE 2001 – REVISED SEPTEMBER 2001

absolute maximum ratings over operating free-air temperature range (unless otherwise noted)†

Supply voltage range, V_{CC} and BIAS V_{CC}	–0.5 V to 4.6 V
Input voltage range, V_I (see Note 1): AI port, ERC, and control inputs	–0.5 V to 7 V
B port and V_{REF}	–0.5 V to 4.6 V
Voltage range applied to any output in the high-impedance or power-off state, V_O (see Note 1): AO port	–0.5 V to 7 V
B port	–0.5 V to 4.6 V
Current into any output in the low state, I_O : AO port	24 mA
B port	200 mA
Current into any A-port output in the high state, I_O (see Note 2)	24 mA
Continuous current through each V_{CC} or GND	±100 mA
Input clamp current, I_{IK} ($V_I < 0$)	–50 mA
Output clamp current, I_{OK} ($V_O < 0$)	–50 mA
Package thermal impedance, θ_{JA} (see Note 3): DGG package	70°C/W
DGV package	58°C/W
GQL package	42°C/W
Storage temperature range, T_{stg}	–65°C to 150°C

† Stresses beyond those listed under “absolute maximum ratings” may cause permanent damage to the device. These are stress ratings only, and functional operation of the device at these or any other conditions beyond those indicated under “recommended operating conditions” is not implied. Exposure to absolute-maximum-rated conditions for extended periods may affect device reliability.

- NOTES: 1. The input and output negative-voltage ratings may be exceeded if the input and output clamp-current ratings are observed.
 2. This current flows only when the output is in the high state and $V_O > V_{CC}$.
 3. The package thermal impedance is calculated in accordance with JESD 51-7.



8-BIT LVTTTL-TO-GTLP ADJUSTABLE-EDGE-RATE REGISTERED TRANSCEIVER WITH SPLIT LVTTTL PORT AND FEEDBACK PATH

SCES355C – JUNE 2001 – REVISED SEPTEMBER 2001

recommended operating conditions (see Notes 4 through 7)

		MIN	NOM	MAX	UNIT	
V_{CC} , BIAS V_{CC}	Supply voltage	3.15	3.3	3.45	V	
V_{TT}	Termination voltage	GTL	1.14	1.2	1.26	V
		GTLP	1.35	1.5	1.65	
V_{REF}	Reference voltage	GTL	0.74	0.8	0.87	V
		GTLP	0.87	1	1.1	
V_I	Input voltage	B port	V_{TT}		V	
		Except B port and V_{REF}	V_{CC}	5.5		
V_{IH}	High-level input voltage	B port	$V_{REF}+0.05$		V	
		Except B port	2			
V_{IL}	Low-level input voltage	B port	$V_{REF}-0.05$		V	
		Except B port	0.8			
I_{IK}	Input clamp current			-18	mA	
I_{OH}	High-level output current	AO			-12	mA
I_{OL}	Low-level output current	AO			12	mA
		B port			100	
$\Delta t/\Delta v$	Input transition rise or fall rate	Outputs enabled		10	ns/V	
$\Delta t/\Delta V_{CC}$	Power-up ramp rate	20			$\mu\text{s}/\text{V}$	
T_A	Operating free-air temperature	-40		85	$^{\circ}\text{C}$	

- NOTES: 4. All unused control and B-port inputs of the device must be held at V_{CC} or GND to ensure proper device operation. Refer to the TI application report, *Implications of Slow or Floating CMOS Inputs*, literature number SCBA004.
5. Proper connection sequence for use of the B-port I/O precharge feature is GND and BIAS $V_{CC} = 3.3$ V first, I/O second, and $V_{CC} = 3.3$ V last, because the BIAS V_{CC} precharge circuitry is disabled when any V_{CC} pin is connected. The control and V_{REF} inputs can be connected anytime, but normally are connected during the I/O stage. If B-port precharge is not required, any connection sequence is acceptable but, generally, GND is connected first.
6. V_{TT} and R_{TT} can be adjusted to accommodate backplane impedances if the dc recommended I_{OL} ratings are not exceeded.
7. V_{REF} can be adjusted to optimize noise margins, but normally is two-thirds V_{TT} . TI-OPC circuitry is enabled in the A-to-B direction and is activated when $V_{TT} > 0.7$ V above V_{REF} . If operated in the A-to-B direction, V_{REF} should be set to within 0.6 V of V_{TT} to minimize current drain.

SN74GTLP22034

8-BIT LVTTTL-TO-GTLP ADJUSTABLE-EDGE-RATE REGISTERED TRANSCEIVER WITH SPLIT LVTTTL PORT AND FEEDBACK PATH

SCES355C – JUNE 2001 – REVISED SEPTEMBER 2001

electrical characteristics over recommended operating free-air temperature range for GTLP (unless otherwise noted)

PARAMETER		TEST CONDITIONS		MIN	TYP†	MAX	UNIT
V_{IK}		$V_{CC} = 3.15\text{ V}$, $I_I = -18\text{ mA}$				-1.2	V
V_{OH}	AO	$V_{CC} = 3.15\text{ V to } 3.45\text{ V}$, $I_{OH} = -100\text{ }\mu\text{A}$		$V_{CC}-0.2$			V
		$V_{CC} = 3.15\text{ V}$		2.4			
V_{OL}	AO	$V_{CC} = 3.15\text{ V to } 3.45\text{ V}$, $I_{OL} = 100\text{ }\mu\text{A}$				0.2	V
		$V_{CC} = 3.15\text{ V}$		$I_{OL} = 6\text{ mA}$		0.55	
				$I_{OL} = 12\text{ mA}$		0.8	
	B port	$V_{CC} = 3.15\text{ V}$		$I_{OL} = 10\text{ mA}$		0.2	
				$I_{OL} = 64\text{ mA}$		0.4	
				$I_{OL} = 100\text{ mA}$		0.55	
$I_{I\ddagger}$	AI and control inputs	$V_{CC} = 3.45\text{ V}$, $V_I = 0\text{ or } 5.5\text{ V}$				± 10	μA
$I_{OZ\ddagger}$	AO	$V_{CC} = 3.45\text{ V}$, $V_O = 0\text{ to } 5.5\text{ V}$				± 10	μA
	B port	$V_{CC} = 3.45\text{ V}$, V_{REF} within 0.6 V of V_{TT} , $V_O = 0\text{ to } 2.3\text{ V}$				± 10	
I_{CC}	AO or B port	$V_{CC} = 3.45\text{ V}$, $I_O = 0$, V_I (A-port or control input) = V_{CC} or GND, V_I (B port) = V_{TT} or GND		Outputs high		40	mA
				Outputs low		40	
				Outputs disabled		40	
$\Delta I_{CC}\S$		$V_{CC} = 3.45\text{ V}$, One AI or control input at $V_{CC} - 0.6\text{ V}$, Other AI or control inputs at V_{CC} or GND				1.5	mA
C_i	AI	$V_I = 3.15\text{ V or } 0$			3.5	4.5	pF
	Control inputs				3.5	5.5	
C_o	AO	$V_O = 3.15\text{ V or } 0$			5	6	pF
C_{io}	B port	$V_O = 1.5\text{ V or } 0$			8.5	10	pF

† All typical values are at $V_{CC} = 3.3\text{ V}$, $T_A = 25^\circ\text{C}$.

‡ For I/O ports, the parameter I_{OZ} includes the input leakage current.

§ This is the increase in supply current for each input that is at the specified TTL voltage level rather than V_{CC} or GND.

hot-insertion specifications for A port over recommended operating free-air temperature range

PARAMETER	TEST CONDITIONS			MIN	MAX	UNIT
I_{off}	$V_{CC} = 0$,	V_I or $V_O = 0\text{ to } 5.5\text{ V}$			10	μA
I_{OZPU}	$V_{CC} = 0\text{ to } 1.5\text{ V}$,	$V_O = 0.5\text{ V to } 3\text{ V}$,	$OEBA = V_{CC}$		± 30	μA
I_{OZPD}	$V_{CC} = 1.5\text{ V to } 0$,	$V_O = 0.5\text{ V to } 3\text{ V}$,	$OEBA = V_{CC}$		± 30	μA

live-insertion specifications for B port over recommended operating free-air temperature range

PARAMETER	TEST CONDITIONS			MIN	MAX	UNIT
I_{off}	$V_{CC} = 0$,	BIAS $V_{CC} = 0$,	V_I or $V_O = 0\text{ to } 1.5\text{ V}$		10	μA
I_{OZPU}	$V_{CC} = 0\text{ to } 1.5\text{ V}$,	BIAS $V_{CC} = 0$, $V_O = 0.5\text{ V to } 1.5\text{ V}$, $\overline{OEAB} = 0$ and $OEAB = V_{CC}$			± 30	μA
I_{OZPD}	$V_{CC} = 1.5\text{ V to } 0$,	BIAS $V_{CC} = 0$, $V_O = 0.5\text{ V to } 1.5\text{ V}$, $\overline{OEAB} = 0$ and $OEAB = V_{CC}$			± 30	μA
I_{CC} (BIAS V_{CC})	$V_{CC} = 0\text{ to } 3.15\text{ V}$	BIAS $V_{CC} = 3.15\text{ V to } 3.45\text{ V}$, V_O (B port) = $0\text{ to } 1.5\text{ V}$			5	mA
	$V_{CC} = 3.15\text{ V to } 3.45\text{ V}$				10	μA
V_O	$V_{CC} = 0$,	BIAS $V_{CC} = 3.3\text{ V}$,	$I_O = 0$	0.95	1.05	V
I_O	$V_{CC} = 0$,	BIAS $V_{CC} = 3.15\text{ V to } 3.45\text{ V}$,	V_O (B port) = 0.6 V	-1		μA



SN74GTLP22034

**8-BIT LVTTTL-TO-GTLP ADJUSTABLE-EDGE-RATE REGISTERED TRANSCEIVER
WITH SPLIT LVTTTL PORT AND FEEDBACK PATH**

SCES355C – JUNE 2001 – REVISED SEPTEMBER 2001

timing requirements over recommended ranges of supply voltage and operating free-air temperature, $V_{TT} = 1.5\text{ V}$ and $V_{REF} = 1\text{ V}$ for GTLP (unless otherwise noted)

		MIN	MAX	UNIT
f_{clock}	Clock frequency		175	MHz
t_w	Pulse duration	CLKAB/LEAB or CLKBA/LEBA		ns
t_{su}	Setup time	A1 before CLKAB \uparrow		1.1
		A1 before CLKBA \uparrow		1.4
		B before CLKBA \uparrow		1.3
		A1 before LEAB \downarrow		1.3
		A1 before LEBA \downarrow		2.1
		B before LEBA \downarrow		2.2
t_h	Hold time	A1 after CLKAB \uparrow		0.3
		A1 after CLKBA \uparrow		0.2
		B after CLKBA \uparrow		0.2
		A1 after LEAB \downarrow		0.3
		A1 after LEBA \downarrow		0
		B after LEBA \downarrow		0



SN74GTLP22034

**8-BIT LVTTTL-TO-GTLP ADJUSTABLE-EDGE-RATE REGISTERED TRANSCEIVER
WITH SPLIT LVTTTL PORT AND FEEDBACK PATH**

SCES355C – JUNE 2001 – REVISED SEPTEMBER 2001

switching characteristics over recommended ranges of supply voltage and operating free-air temperature, $V_{TT} = 1.5\text{ V}$ and $V_{REF} = 1\text{ V}$ for GTLP (see Figure 1)

PARAMETER	FROM (INPUT)	TO (OUTPUT)	EDGE RATE†	MIN	TYP‡	MAX	UNIT
f_{max}				175			MHz
t_{PLH}	AI (buffer)	B	Slow	3	7.1	7	ns
t_{PHL}				3	7		
t_{PLH}	AI (buffer)	B	Fast	2	5.6	5.7	ns
t_{PHL}				2	5.7		
t_{PLH}	B (buffer)	AO	–	1	5.8	5.2	ns
t_{PHL}				1	5.2		
t_{PLH}	LEAB (latch mode)	B	Slow	4.2	8.5	7.3	ns
t_{PHL}				3.2	7.3		
t_{PLH}	LEAB (latch mode)	B	Fast	3.2	7.1	6.3	ns
t_{PHL}				2.8	6.3		
t_{PLH}	LEAB (latch mode)	AO	–	2	6.9	6.1	ns
t_{PHL}				1.8	6.1		
t_{PLH}	LEBA (latch mode)	AO	–	1	5.6	5	ns
t_{PHL}				1	5		
t_{PLH}	OEAB	B	Slow	3.8	7.5	7	ns
t_{PHL}				3.1	7		
t_{PLH}	OEAB	B	Fast	2.5	6	6	ns
t_{PHL}				2.5	6		
t_{PLH}	\overline{OEAB}	B	Slow	3.5	7.5	7.2	ns
t_{PHL}				3	7.2		
t_{PLH}	\overline{OEAB}	B	Fast	2.5	6	6	ns
t_{PHL}				2.5	6		
t_{PZH}	OEBA	AO	–	1	5.3	4.2	ns
t_{PZL}				1	4.2		
t_{PHZ}	OEBA	AO	–	1	5.5	5.2	ns
t_{PLZ}				1	5.2		
t_{PLH}	CLKAB (flip-flop mode)	B	Slow	4.4	8.6	8	ns
t_{PHL}				3.6	8		
t_{PLH}	CLKAB (flip-flop mode)	B	Fast	3.2	7.1	6.8	ns
t_{PHL}				3.1	6.8		
t_{PLH}	CLKAB (flip-flop mode)	AO	–	2	7.5	7	ns
t_{PHL}				1.8	7		
t_{PLH}	CLKBA (flip-flop mode)	AO	–	1	6	5.6	ns
t_{PHL}				1	5.6		
t_{PLH}	OMODE	B	Slow	3.8	8.7	8.2	ns
t_{PHL}				3.2	8.2		
t_{PLH}	OMODE	B	Fast	2.7	7	7	ns
t_{PHL}				2.7	7		
t_{PLH}	IMODE	AO	–	1	6	5.1	ns
t_{PHL}				1	5.1		

† Slow (ERC = H) and Fast (ERC = L)

‡ All typical values are at $V_{CC} = 3.3\text{ V}$, $T_A = 25^\circ\text{C}$.



8-BIT LVTTTL-TO-GTLP ADJUSTABLE-EDGE-RATE REGISTERED TRANSCEIVER WITH SPLIT LVTTTL PORT AND FEEDBACK PATH

SCES355C – JUNE 2001 – REVISED SEPTEMBER 2001

switching characteristics over recommended ranges of supply voltage and operating free-air temperature, $V_{TT} = 1.5\text{ V}$ and $V_{REF} = 1\text{ V}$ for GTLP (see Figure 1) (continued)

PARAMETER	FROM (INPUT)	TO (OUTPUT)	EDGE RATE†	MIN	TYP‡	MAX	UNIT
t_{PLH}	LOOPBACK	AO	–	2.5		6.1	ns
t_{PHL}				2	5.1		
t_{PLH}	AI (loopback high)	AO	–	1		5.7	ns
t_{PHL}				1	5.4		
t_r	Rise time, B-port outputs (20% to 80%)		Slow	2.8		ns	
			Fast	1.5			
	Rise time, AO (10% to 90%)			5.5			
t_f	Fall time, B-port outputs (80% to 20%)		Slow	3		ns	
			Fast	1.8			
	Fall time, AO (90% to 10%)			4.5			

† Slow (ERC = H) and Fast (ERC = L)

‡ All typical values are at $V_{CC} = 3.3\text{ V}$, $T_A = 25^\circ\text{C}$.

skew characteristics over recommended ranges of supply voltage and operating free-air temperature (see Figure 1)§

PARAMETER	FROM (INPUT)	TO (OUTPUT)	EDGE RATE†	MIN	TYP‡	MAX	UNIT
$t_{sk(LH)}^{\parallel}$	AI	B	Slow	0.5		1	ns
$t_{sk(HL)}^{\parallel}$				0.5	1		
$t_{sk(LH)}^{\parallel}$	AI	B	Fast	0.4		0.9	ns
$t_{sk(HL)}^{\parallel}$				0.4	0.9		
$t_{sk(LH)}^{\parallel}$	CLKAB/LEAB	B	Slow	0.5		1	ns
$t_{sk(HL)}^{\parallel}$				0.5	1		
$t_{sk(LH)}^{\parallel}$	CLKAB/LEAB	B	Fast	0.4		0.9	ns
$t_{sk(HL)}^{\parallel}$				0.4	0.9		
$t_{sk(t)}^{\parallel}$	AI	B	Slow	1.4		2	ns
			Fast	0.6	1.4		
	CLKAB/LEAB	B	Slow	1.8		2.5	
			Fast	0.9	1.8		

† Slow (ERC = L) and Fast (ERC = H)

‡ All typical values are at $V_{CC} = 3.3\text{ V}$, $T_A = 25^\circ\text{C}$.

§ Actual skew values between the GTLP outputs could vary on the backplane due to the loading and impedance seen by the device.

¶ $t_{sk(LH)}/t_{sk(HL)}$ and $t_{sk(t)}$ – Output-to-output skew is defined as the absolute value of the difference between the actual propagation delay for all outputs with the same packaged device. The specifications are given for specific worst-case V_{CC} and temperature and apply to any outputs switching in the same direction either high to low [$t_{sk(HL)}$] or low to high [$t_{sk(LH)}$] or in opposite directions, both low to high and high to low [$t_{sk(t)}$].



SN74GTLP22034 8-BIT LVTTTL-TO-GTLP ADJUSTABLE-EDGE-RATE REGISTERED TRANSCEIVER WITH SPLIT LVTTTL PORT AND FEEDBACK PATH

SCES355C – JUNE 2001 – REVISED SEPTEMBER 2001

PARAMETER MEASUREMENT INFORMATION

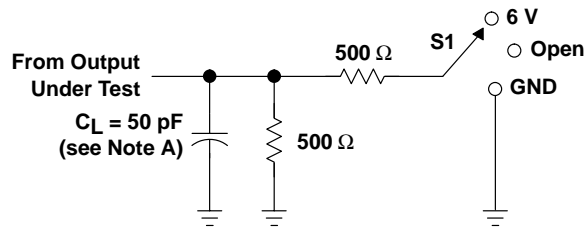

LOAD CIRCUIT FOR A OUTPUTS

TEST	S1
tPLH/tPHL	Open
tPLZ/tPZL	6 V
tPHZ/tPZH	GND

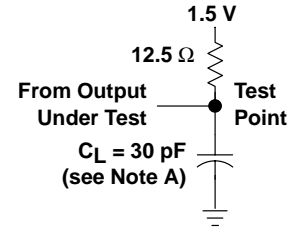

LOAD CIRCUIT FOR B OUTPUTS

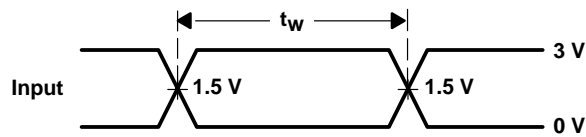

VOLTAGE WAVEFORMS
PULSE DURATION

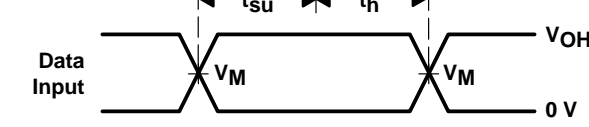
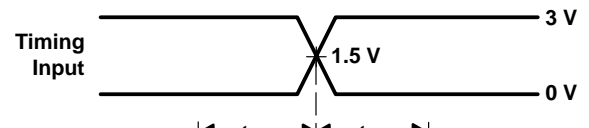

VOLTAGE WAVEFORMS
SETUP AND HOLD TIMES
(VM = 1.5 V for A port and 1 V for B port)
(VOH = 3 V for A port and 1.5 V for B port)

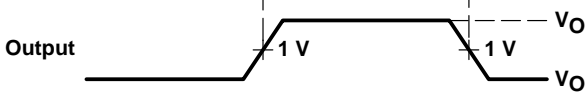
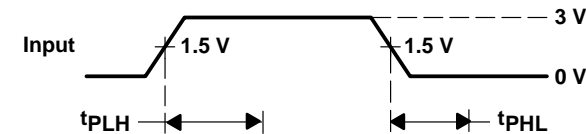

VOLTAGE WAVEFORMS
PROPAGATION DELAY TIMES
(A to B port)

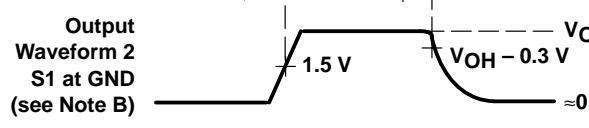
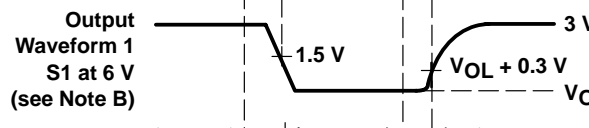
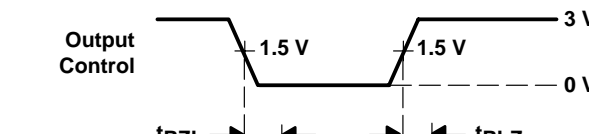

VOLTAGE WAVEFORMS
ENABLE AND DISABLE TIMES
(AO)

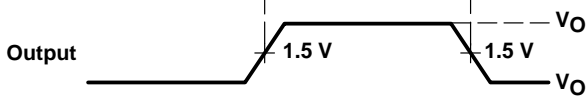
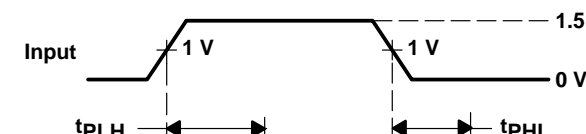

VOLTAGE WAVEFORMS
PROPAGATION DELAY TIMES
(B port to AO)

- NOTES: A. CL includes probe and jig capacitance.
 B. Waveform 1 is for an output with internal conditions such that the output is low except when disabled by the output control. Waveform 2 is for an output with internal conditions such that the output is high except when disabled by the output control.
 C. All input pulses are supplied by generators having the following characteristics: PRR = 10 MHz, ZO = 50 Ω, tr ≈ 2 ns, tf ≈ 2 ns.
 D. The outputs are measured one at a time with one transition per measurement.

Figure 1. Load Circuits and Voltage Waveforms

DISTRIBUTED-LOAD BACKPLANE SWITCHING CHARACTERISTICS

The preceding switching characteristics table shows the switching characteristics of the device into a lumped load (Figure 1). However, the designer's backplane application is probably a distributed load. The physical representation is shown in Figure 2. This backplane, or distributed load, can be approximated closely to a resistor inductance capacitance (RLC) circuit, as shown in Figure 3. This device has been designed for optimum performance in this RLC circuit. The following switching characteristics table shows the switching characteristics of the device into the RLC load, to help the designer to better understand the performance of the GTLP device in this typical backplane. See www.ti.com/sc/gtlp for more information.

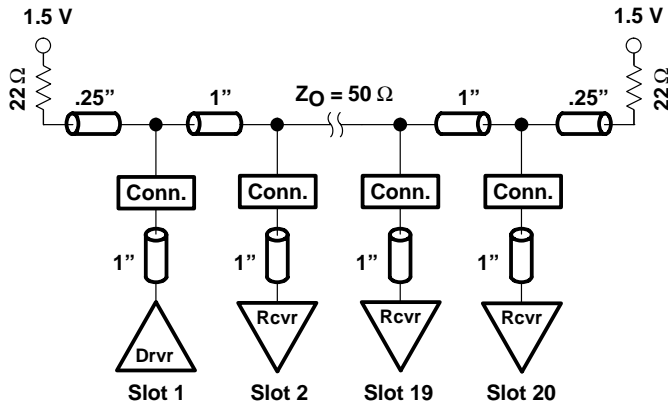

Figure 2. High-Drive Test Backplane

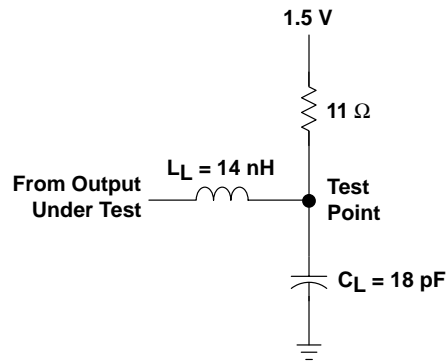

Figure 3. High-Drive RLC Network

SN74GTLP22034

**8-BIT LVTTTL-TO-GTLP ADJUSTABLE-EDGE-RATE REGISTERED TRANSCEIVER
WITH SPLIT LVTTTL PORT AND FEEDBACK PATH**

SCES355C – JUNE 2001 – REVISED SEPTEMBER 2001

switching characteristics over recommended operating conditions for the bus transceiver function (unless otherwise noted) (see Figure 3)

PARAMETER	FROM (INPUT)	TO (OUTPUT)	EDGE RATE†	TYP‡	UNIT
t _{PLH}	AI (buffer)	B	Slow	5.7	ns
t _{PHL}				5.2	
t _{PLH}	AI (buffer)	B	Fast	3.7	ns
t _{PHL}				4.1	
t _{PLH}	LEAB (latch mode)	B	Slow	5.9	ns
t _{PHL}				5.7	
t _{PLH}	LEAB (latch mode)	B	Fast	4.8	ns
t _{PHL}				4.8	
t _{PLH}	CLKAB (flip-flop mode)	B	Slow	5.7	ns
t _{PHL}				6.4	
t _{PLH}	CLKAB (flip-flop mode)	B	Fast	4.7	ns
t _{PHL}				5.2	
t _{PLH}	OMODE	B	Slow	5.4	ns
t _{PHL}				6	
t _{PLH}	OMODE	B	Fast	4.5	ns
t _{PHL}				4.9	
t _r	Rise time, B-port outputs (20% to 80%)		Slow	2	ns
			Fast	1.1	
t _f	Fall time, B-port outputs (80% to 20%)		Slow	3.3	ns
			Fast	2.3	

† Slow (ERC = H) and Fast (ERC = L)

‡ All typical values are at V_{CC} = 3.3 V, T_A = 25°C. All values are derived from TI-SPICE models.

PACKAGING INFORMATION

Orderable Device	Status ⁽¹⁾	Package Type	Package Drawing	Pins	Package Qty	Eco Plan ⁽²⁾	Lead/Ball Finish	MSL Peak Temp ⁽³⁾
74GTLP22034DGGRE4	ACTIVE	TSSOP	DGG	48	2000	Green (RoHS & no Sb/Br)	CU NIPDAU	Level-1-260C-UNLIM
74GTLP22034DGGRG4	ACTIVE	TSSOP	DGG	48	2000	Green (RoHS & no Sb/Br)	CU NIPDAU	Level-1-260C-UNLIM
74GTLP22034DGVRE4	ACTIVE	TVSOP	DGV	48	2000	Green (RoHS & no Sb/Br)	CU NIPDAU	Level-1-260C-UNLIM
74GTLP22034DGVRG4	ACTIVE	TVSOP	DGV	48	2000	Green (RoHS & no Sb/Br)	CU NIPDAU	Level-1-260C-UNLIM
SN74GTLP22034DGGR	ACTIVE	TSSOP	DGG	48	2000	Green (RoHS & no Sb/Br)	CU NIPDAU	Level-1-260C-UNLIM
SN74GTLP22034DGVR	ACTIVE	TVSOP	DGV	48	2000	Green (RoHS & no Sb/Br)	CU NIPDAU	Level-1-260C-UNLIM
SN74GTLP22034GQLR	NRND	BGA MI CROSTA R JUNI OR	GQL	56	1000	TBD	SNPB	Level-1-240C-UNLIM
SN74GTLP22034ZQLR	ACTIVE	BGA MI CROSTA R JUNI OR	ZQL	56	1000	Green (RoHS & no Sb/Br)	SNAGCU	Level-1-260C-UNLIM

⁽¹⁾ The marketing status values are defined as follows:

ACTIVE: Product device recommended for new designs.

LIFEBUY: TI has announced that the device will be discontinued, and a lifetime-buy period is in effect.

NRND: Not recommended for new designs. Device is in production to support existing customers, but TI does not recommend using this part in a new design.

PREVIEW: Device has been announced but is not in production. Samples may or may not be available.

OBSOLETE: TI has discontinued the production of the device.

⁽²⁾ Eco Plan - The planned eco-friendly classification: Pb-Free (RoHS), Pb-Free (RoHS Exempt), or Green (RoHS & no Sb/Br) - please check <http://www.ti.com/productcontent> for the latest availability information and additional product content details.

TBD: The Pb-Free/Green conversion plan has not been defined.

Pb-Free (RoHS): TI's terms "Lead-Free" or "Pb-Free" mean semiconductor products that are compatible with the current RoHS requirements for all 6 substances, including the requirement that lead not exceed 0.1% by weight in homogeneous materials. Where designed to be soldered at high temperatures, TI Pb-Free products are suitable for use in specified lead-free processes.

Pb-Free (RoHS Exempt): This component has a RoHS exemption for either 1) lead-based flip-chip solder bumps used between the die and package, or 2) lead-based die adhesive used between the die and leadframe. The component is otherwise considered Pb-Free (RoHS compatible) as defined above.

Green (RoHS & no Sb/Br): TI defines "Green" to mean Pb-Free (RoHS compatible), and free of Bromine (Br) and Antimony (Sb) based flame retardants (Br or Sb do not exceed 0.1% by weight in homogeneous material)

⁽³⁾ MSL, Peak Temp. -- The Moisture Sensitivity Level rating according to the JEDEC industry standard classifications, and peak solder temperature.

Important Information and Disclaimer:The information provided on this page represents TI's knowledge and belief as of the date that it is provided. TI bases its knowledge and belief on information provided by third parties, and makes no representation or warranty as to the accuracy of such information. Efforts are underway to better integrate information from third parties. TI has taken and continues to take reasonable steps to provide representative and accurate information but may not have conducted destructive testing or chemical analysis on incoming materials and chemicals. TI and TI suppliers consider certain information to be proprietary, and thus CAS numbers and other limited information may not be available for release.

In no event shall TI's liability arising out of such information exceed the total purchase price of the TI part(s) at issue in this document sold by TI to Customer on an annual basis.

TAPE AND REEL INFORMATION



QUADRANT ASSIGNMENTS FOR PIN 1 ORIENTATION IN TAPE



*All dimensions are nominal

Device	Package Type	Package Drawing	Pins	SPQ	Reel Diameter (mm)	Reel Width W1 (mm)	A0 (mm)	B0 (mm)	K0 (mm)	P1 (mm)	W (mm)	Pin1 Quadrant
SN74GTLP22034DGGR	TSSOP	DGG	48	2000	330.0	24.4	8.6	15.8	1.8	12.0	24.0	Q1
SN74GTLP22034DGVR	TVSOP	DGV	48	2000	330.0	24.4	6.8	10.1	1.6	12.0	24.0	Q1
SN74GTLP22034GQLR	BGA MICROSTAR JUNIOR	GQL	56	1000	330.0	16.4	4.8	7.3	1.45	8.0	16.0	Q1
SN74GTLP22034ZQLR	BGA MICROSTAR JUNIOR	ZQL	56	1000	330.0	16.4	4.8	7.3	1.45	8.0	16.0	Q1

TAPE AND REEL BOX DIMENSIONS



*All dimensions are nominal

Device	Package Type	Package Drawing	Pins	SPQ	Length (mm)	Width (mm)	Height (mm)
SN74GTLP22034DGGR	TSSOP	DGG	48	2000	346.0	346.0	41.0
SN74GTLP22034DGVR	TVSOP	DGV	48	2000	346.0	346.0	41.0
SN74GTLP22034GQLR	BGA MICROSTAR JUNIOR	GQL	56	1000	346.0	346.0	33.0
SN74GTLP22034ZQLR	BGA MICROSTAR JUNIOR	ZQL	56	1000	346.0	346.0	33.0

GQL (R-PBGA-N56)

PLASTIC BALL GRID ARRAY

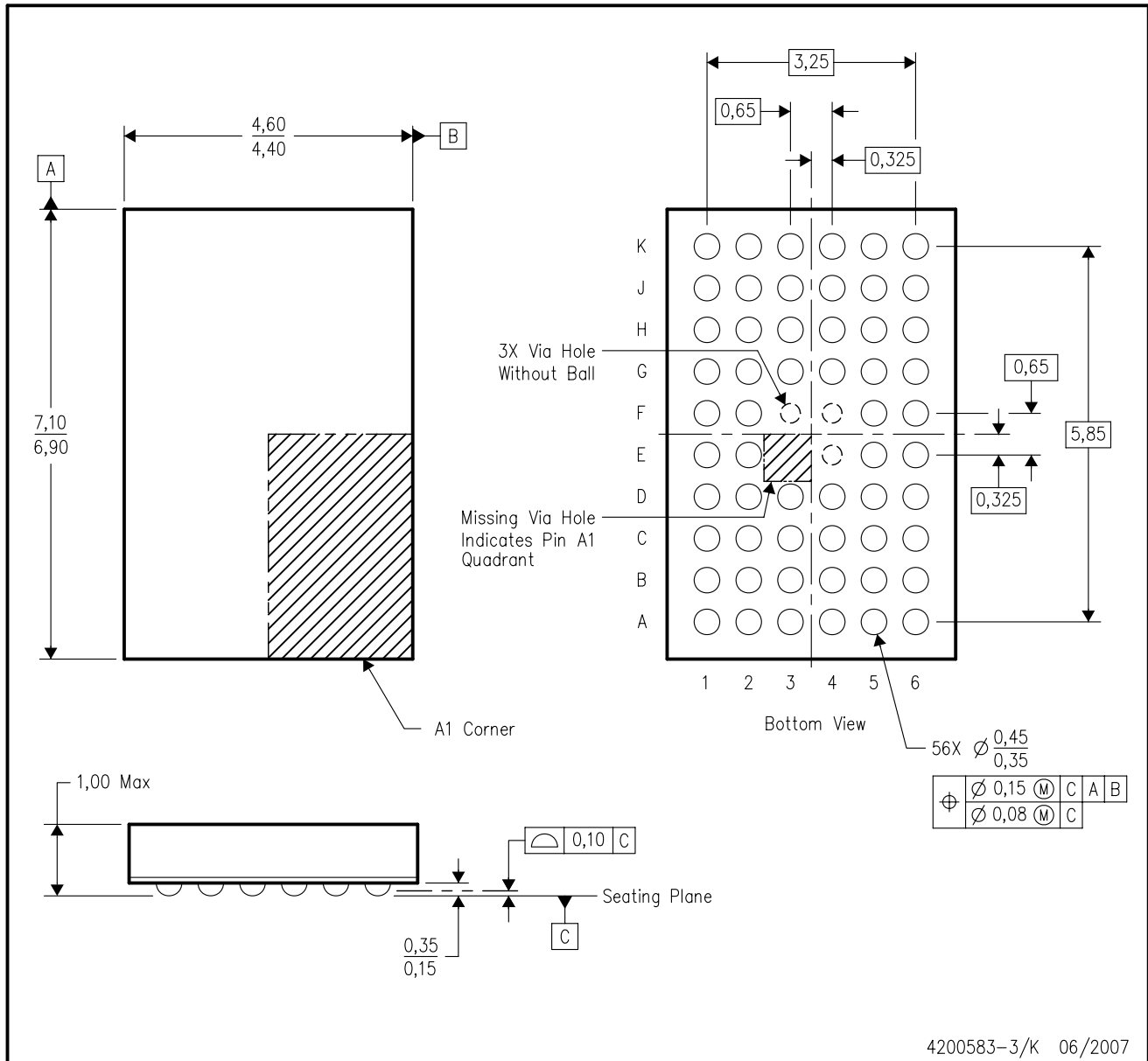

- NOTES:
- All linear dimensions are in millimeters. Dimensioning and tolerancing per ASME Y14.5M-1994.
 - This drawing is subject to change without notice.
 - Falls within JEDEC MO-285 variation BA-2.
 - This package is tin-lead (SnPb). Refer to the 56 ZQL package (drawing 4204437) for lead-free.

ZQL (R-PBGA-N56)

PLASTIC BALL GRID ARRAY



- NOTES:
- A. All linear dimensions are in millimeters. Dimensioning and tolerancing per ASME Y14.5M-1994.
 - B. This drawing is subject to change without notice.
 - C. Falls within JEDEC MO-285 variation BA-2.
 - D. This package is lead-free. Refer to the 56 GQL package (drawing 4200583) for tin-lead (SnPb).

DGG (R-PDSO-G**)

PLASTIC SMALL-OUTLINE PACKAGE

48 PINS SHOWN



- NOTES: A. All linear dimensions are in millimeters.
 B. This drawing is subject to change without notice.
 C. Body dimensions do not include mold protrusion not to exceed 0,15.
 D. Falls within JEDEC MO-153

DGV (R-PDSO-G**)

PLASTIC SMALL-OUTLINE

24 PINS SHOWN



4073251/E 08/00

- NOTES: A. All linear dimensions are in millimeters.
 B. This drawing is subject to change without notice.
 C. Body dimensions do not include mold flash or protrusion, not to exceed 0,15 per side.
 D. Falls within JEDEC: 24/48 Pins – MO-153
 14/16/20/56 Pins – MO-194

IMPORTANT NOTICE

Texas Instruments Incorporated and its subsidiaries (TI) reserve the right to make corrections, modifications, enhancements, improvements, and other changes to its products and services at any time and to discontinue any product or service without notice. Customers should obtain the latest relevant information before placing orders and should verify that such information is current and complete. All products are sold subject to TI's terms and conditions of sale supplied at the time of order acknowledgment.

TI warrants performance of its hardware products to the specifications applicable at the time of sale in accordance with TI's standard warranty. Testing and other quality control techniques are used to the extent TI deems necessary to support this warranty. Except where mandated by government requirements, testing of all parameters of each product is not necessarily performed.

TI assumes no liability for applications assistance or customer product design. Customers are responsible for their products and applications using TI components. To minimize the risks associated with customer products and applications, customers should provide adequate design and operating safeguards.

TI does not warrant or represent that any license, either express or implied, is granted under any TI patent right, copyright, mask work right, or other TI intellectual property right relating to any combination, machine, or process in which TI products or services are used. Information published by TI regarding third-party products or services does not constitute a license from TI to use such products or services or a warranty or endorsement thereof. Use of such information may require a license from a third party under the patents or other intellectual property of the third party, or a license from TI under the patents or other intellectual property of TI.

Reproduction of TI information in TI data books or data sheets is permissible only if reproduction is without alteration and is accompanied by all associated warranties, conditions, limitations, and notices. Reproduction of this information with alteration is an unfair and deceptive business practice. TI is not responsible or liable for such altered documentation. Information of third parties may be subject to additional restrictions.

Resale of TI products or services with statements different from or beyond the parameters stated by TI for that product or service voids all express and any implied warranties for the associated TI product or service and is an unfair and deceptive business practice. TI is not responsible or liable for any such statements.

TI products are not authorized for use in safety-critical applications (such as life support) where a failure of the TI product would reasonably be expected to cause severe personal injury or death, unless officers of the parties have executed an agreement specifically governing such use. Buyers represent that they have all necessary expertise in the safety and regulatory ramifications of their applications, and acknowledge and agree that they are solely responsible for all legal, regulatory and safety-related requirements concerning their products and any use of TI products in such safety-critical applications, notwithstanding any applications-related information or support that may be provided by TI. Further, Buyers must fully indemnify TI and its representatives against any damages arising out of the use of TI products in such safety-critical applications.

TI products are neither designed nor intended for use in military/aerospace applications or environments unless the TI products are specifically designated by TI as military-grade or "enhanced plastic." Only products designated by TI as military-grade meet military specifications. Buyers acknowledge and agree that any such use of TI products which TI has not designated as military-grade is solely at the Buyer's risk, and that they are solely responsible for compliance with all legal and regulatory requirements in connection with such use.

TI products are neither designed nor intended for use in automotive applications or environments unless the specific TI products are designated by TI as compliant with ISO/TS 16949 requirements. Buyers acknowledge and agree that, if they use any non-designated products in automotive applications, TI will not be responsible for any failure to meet such requirements.

Following are URLs where you can obtain information on other Texas Instruments products and application solutions:

Products

Amplifiers	amplifier.ti.com
Data Converters	dataconverter.ti.com
DSP	dsp.ti.com
Clocks and Timers	www.ti.com/clocks
Interface	interface.ti.com
Logic	logic.ti.com
Power Mgmt	power.ti.com
Microcontrollers	microcontroller.ti.com
RFID	www.ti-rfid.com
RF/IF and ZigBee® Solutions	www.ti.com/lprf

Applications

Audio	www.ti.com/audio
Automotive	www.ti.com/automotive
Broadband	www.ti.com/broadband
Digital Control	www.ti.com/digitalcontrol
Medical	www.ti.com/medical
Military	www.ti.com/military
Optical Networking	www.ti.com/opticalnetwork
Security	www.ti.com/security
Telephony	www.ti.com/telephony
Video & Imaging	www.ti.com/video
Wireless	www.ti.com/wireless

Mailing Address: Texas Instruments, Post Office Box 655303, Dallas, Texas 75265
Copyright © 2008, Texas Instruments Incorporated